

Miroir RIVOLI 750

Réf. 172619

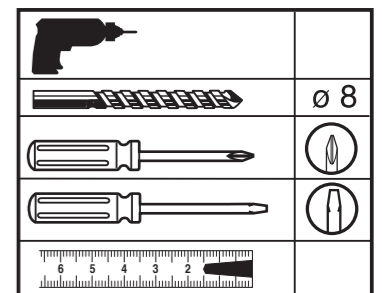
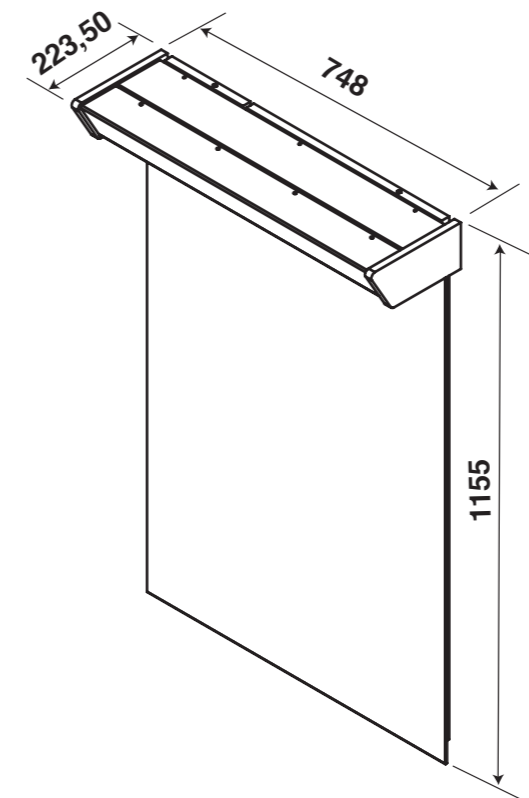

1		VIS 4,5 X 40 TR 706003000103	X 8
2		CHEVILLE 8 706014000035	X 8
3		PAT 368 A 706002000081	X 2
4		ATT 310 706002000005	X 2
		LAMPE FLUO T5 - 13 W L : 540 mm 706013000034	X 2

F Ce miroir CLASSE II IP24 peut être mise dans le volume 2.

GB This mirror CLASSE II IP24 can be put in volume 2.

D Dieser Spiegel CLASSE II IP24 kann in Volumen 2.

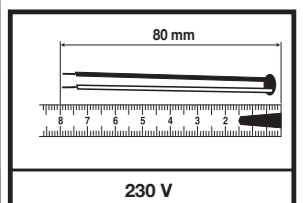
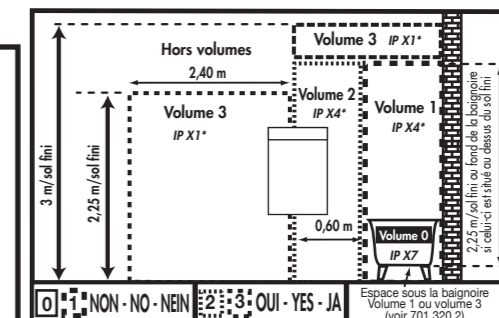

F

- Mettre l'installation électrique hors tension avant de commencer l'installation.
- Choisir l'emplacement du miroir afin que la prise électrique du meuble soit en dehors du volume de sécurité.
- Pour accroître la longévité de votre miroir, nous vous recommandons de chauffer et de ventiler votre salle de bains pour éviter l'accumulation de vapeur et d'essuyer les projections d'eau.
- Pour votre complète satisfaction, respecter les consignes d'installation et d'entretien. Leur non respect peut entraîner la perte de la garantie.

D

- Vor Montagebeginn den Strom abstellen (Sicherung ausschalten).
- Stellplatz auswählen und darauf achten, daß die E-Steckdose für den Spiegel außerhalb des Sicherheitsbereiches liegt.
- Um eine lange Lebensdauer Ihres Spiegel sicherzustellen, empfehlen wir, das Badezimmer zu heizen und zu lüften, um hohe Luftfeuchtigkeit zu vermeiden. Wasserspritzer sollten trockengewischt werden.
- Damit das Möbelstück Sie vollstens zufriedenstellt, beachten Sie bitte die Installations- und Pflegevorschriften. Bei Nichteinhaltung erlischt der Garantie Anspruch.

GB

- Isolate the electrical supply at the fuse box or consumer unit before attempting installation.
- The mirror must be positioned so that the electric socket is outside the electrical safety zone.
- To maximise the service life of your mirror we recommend that your bathroom is properly heated and ventilated. This will prevent the build up of excess moisture and steam stagnation. Wipe with water splashes as they occur with clean cloth.
- For your complete satisfaction carefully read the installation and maintenance instructions provided and retain for reference. Failure to follow the instructions may invalidate the product warranty.

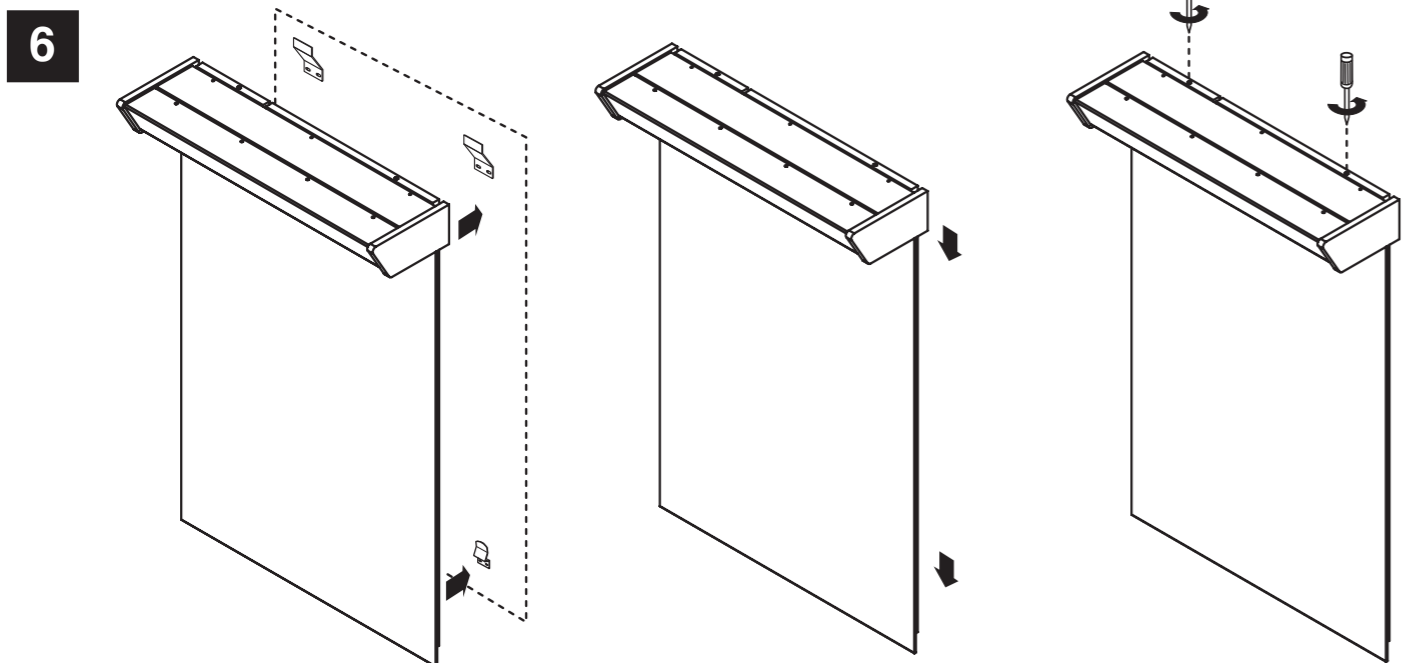
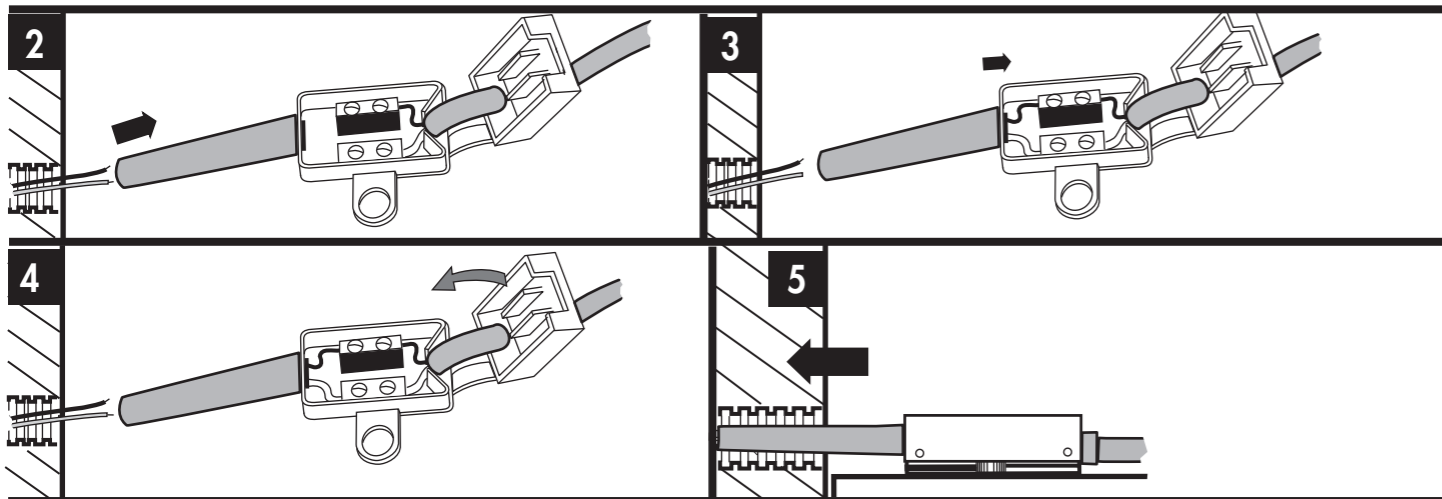
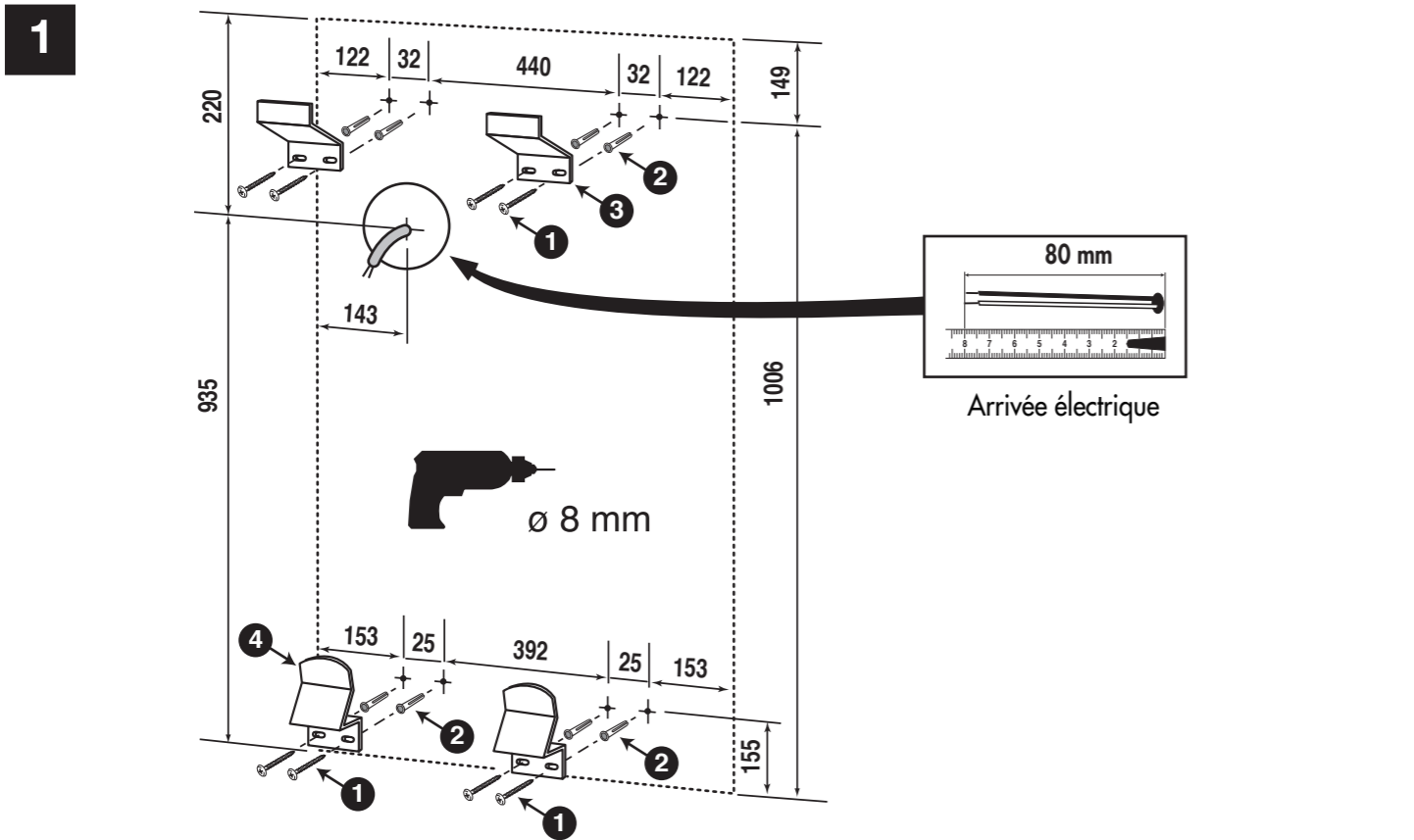

7

F	Changement du tube fluorescent.
D	Leuchtstoffröhre einsetzen.
GB	Changing the fluorescent tube connections.

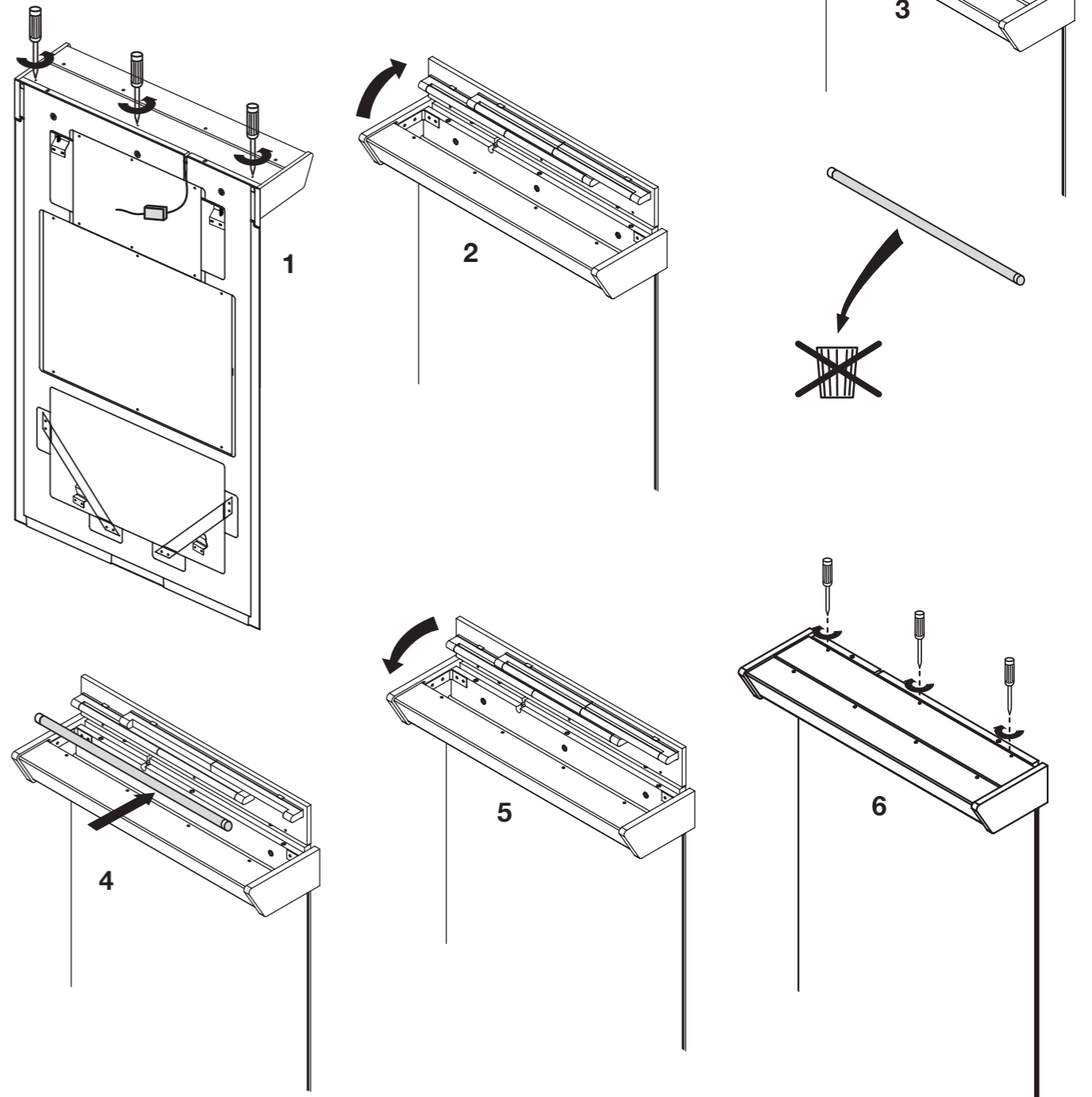

F	Blocage du tube fluo.
D	Leuchtstoffröhre in Socket einrasten.
GB	Tighten the fluorescent tube connections.

