

Réglage flaconnier - Adjustment of drawer - Auszugseinstellung

Montage du tiroir / Insert drawer / Montage des Schubfaches

Démontage du tiroir / Removing drawer / Aushängen

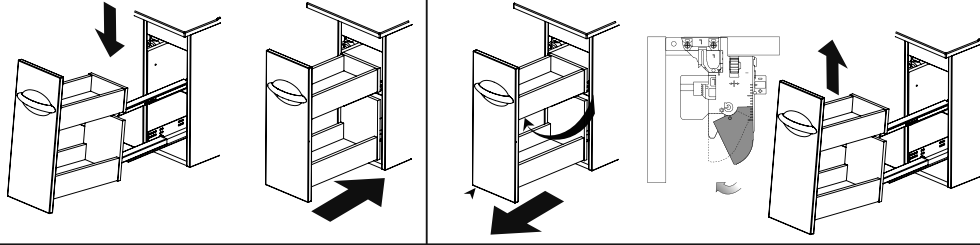

Réglage en hauteur (max. + 3,5 mm)
Height adjustment (max. + 3,5 mm)
Höhenverstellung (max. + 3,5 mm)

Réglage latéral (max. ± 1,5 mm)
Side adjustment (max. ± 1,5 mm)
Seitenverstellung (max. ± 1,5 mm)

Réglage inclinaison (max. + 4 mm)
Tilt angle adjustment of front (max. + 4 mm)
Neigungsverstellung der Front (max. + 4 mm)

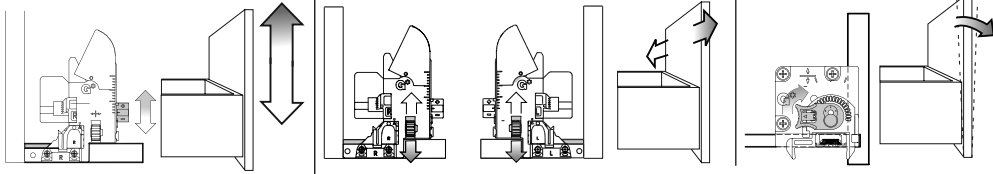

Réglage tiroir - Adjustment of drawer - Auszugseinstellung

Montage du tiroir / Insert drawer / Montage des Schubfaches

Démontage du tiroir / Removing drawer / Aushängen

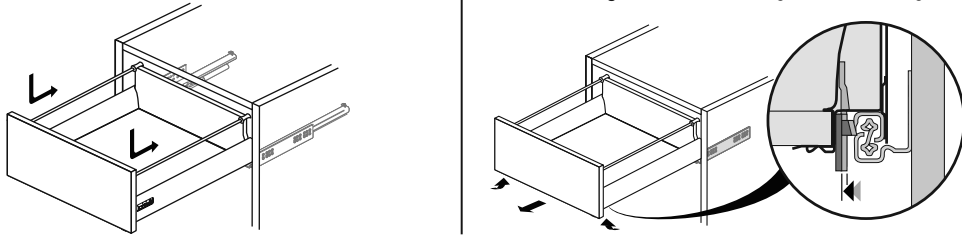

Réglage en hauteur (max. ± 2 mm)
Height adjustment (max. ± 2 mm)
Höhenverstellung (max. ± 2 mm)

Réglage latéral (± 1,5 mm)
Side adjustment (± 1,5 mm)
Seitenverstellung (± 1,5 mm)

Réglage inclinaison (max. + 4 mm)
Tilt angle adjustment of front (max. + 4 mm)
Neigungsverstellung der Front (max. + 4 mm)

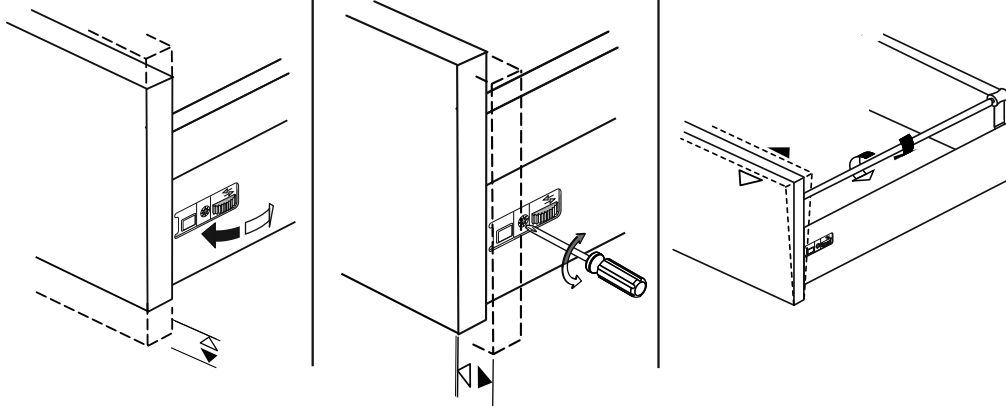

Meuble BENTO 600

Réf: 179001
179008
179009

ver.1 18/05/2012

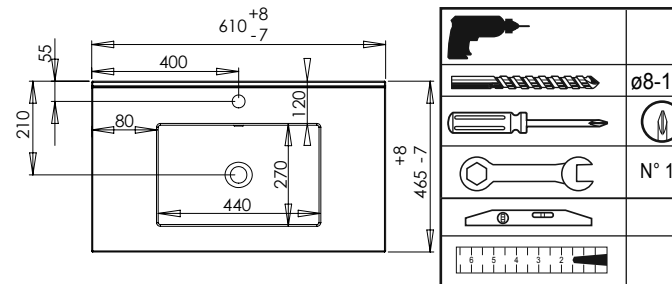
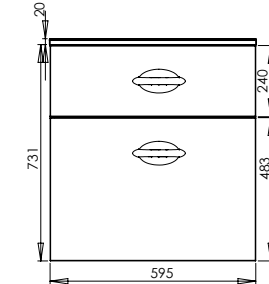
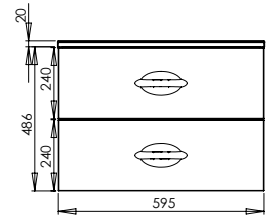
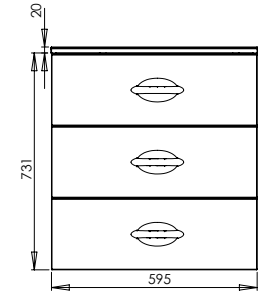
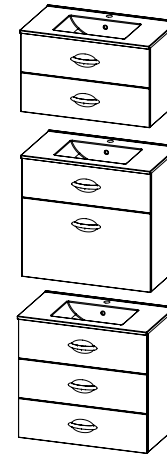

	CHEVILLE 8 706014000035	X 4
	VIS 4,5 X 40 TR 706003000103	X 4
	PLAQUE 273 703001000021	X 2
	CHEVILLE S10 706014000033	X 2
	RONDELLE 8L 706011000040	X 2
	VIS TREFOND 6X50 TH 706003000132	X 2

N79001 MBL BENTO 60 -18/05/2013

F	<ul style="list-style-type: none"> Pour accroître la longévité de vos meubles, nous vous recommandons de chauffer et de ventiler votre salle de bains pour éviter l'accumulation de vapeur et d'essuyer les projections d'eau. Pour votre complète satisfaction, respecter les consignes d'installation et d'entretien. Leur non respect peut entraîner la perte de la garantie.
GB	<ul style="list-style-type: none"> To maximise the service life of furniture units we recommend that your bathroom is properly heated and ventilated. This will prevent the build up of excess moisture and steam stagnation. Wipe with water splashes as they occur with clean cloth. For your complete satisfaction carefully read the installation and maintenance instructions provided and retain for reference. Failure to follow the instructions may invalidate the product warranty.
D	<ul style="list-style-type: none"> Um eine lange Lebensdauer Ihrer Möbel sicherzustellen, empfehlen wir, das Badezimmer zu heizen und zu lüften, um hohe Luftfeuchtigkeit zu vermeiden. Wasserspritzer sollten trockengewischt werden. Damit das Möbelstück Sie vollstens zufriedenstellt, beachten Sie bitte die Installations- und Pflegevorschriften. Bei Nichteinhaltung erlischt der Garantie Anspruch.

PARIS **DECOTEC**

1 Fixation murale - Wall fixing - Wandbefestigung

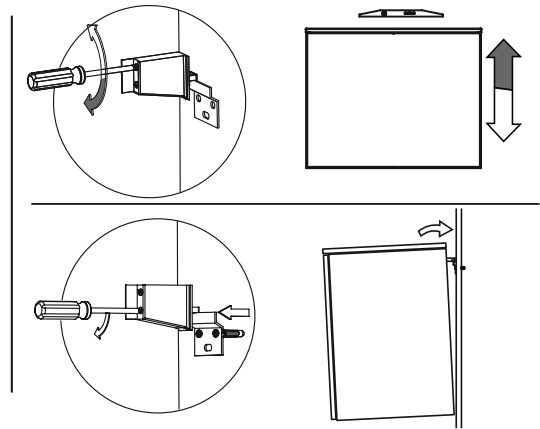
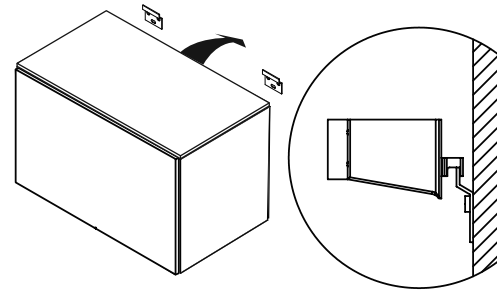
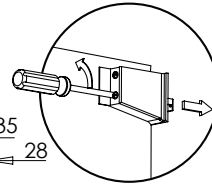
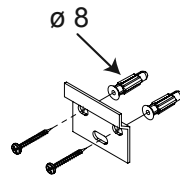
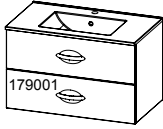
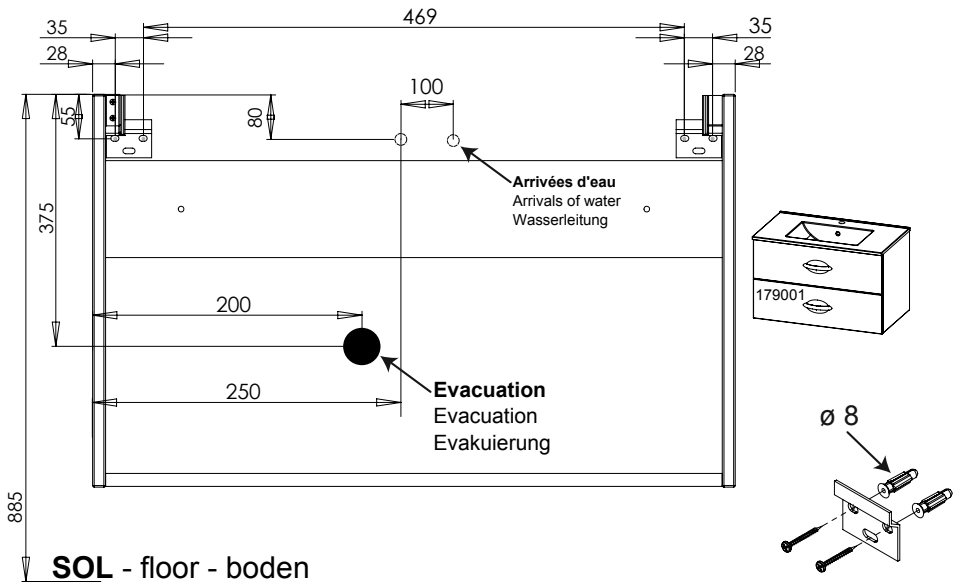

Meuble avec traverse arrière
(traverse = renfort sur l'arrière du caisson
qui vient se plaquer au mur).
Unit with rear support crossbar
Möbel mit Querträger
(Querträger = Verstrebung auf der Möbelrückseite
welche zur Befestigung an der Wand dient).

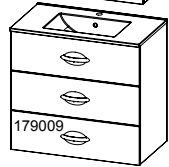
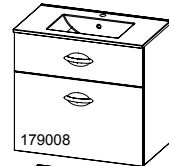
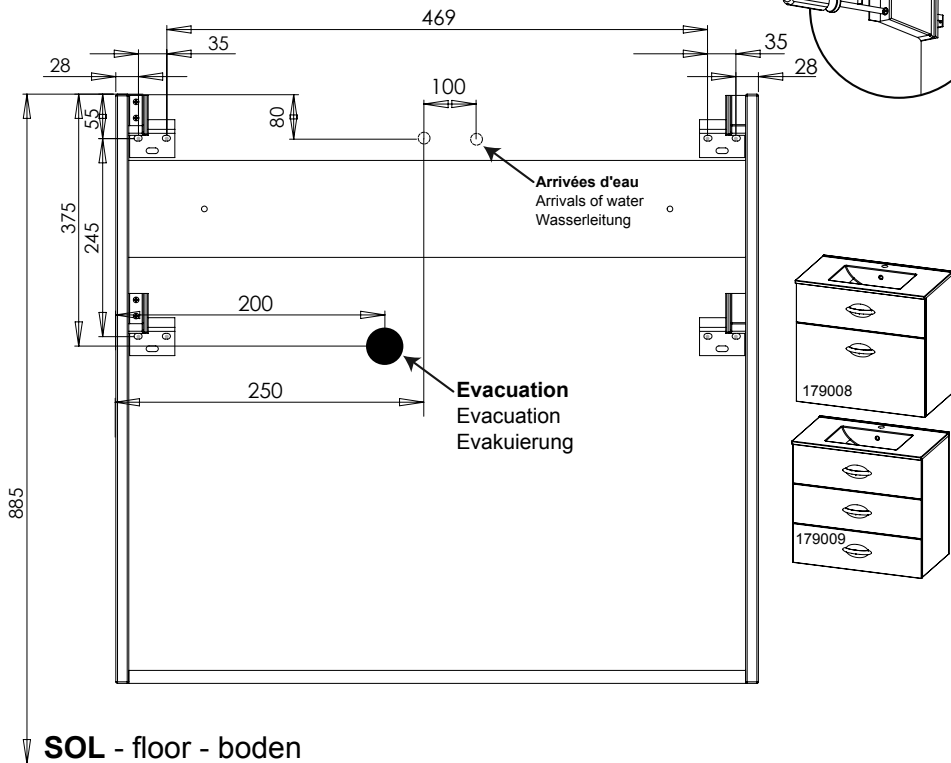
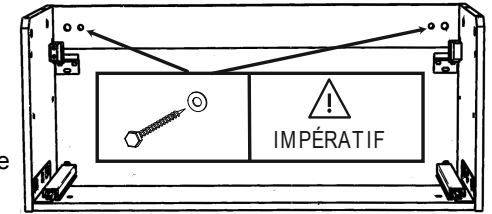

2 Pose plan céramique et plan verre / Installing Ceramic basin and glass top / Aufsetzen & Befestigen des Keramik-Waschtisches / Glas-Waschtisches

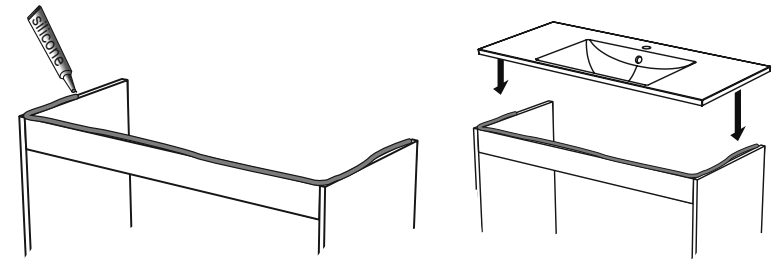

3 Raccordement Fitting instructions - Anschluss für Abfluss

Non fourni
Not supplied
Nicht im Lieferumfang

