

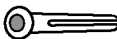



1		CHEVILLE 8	X 4
2		VIS 5 X 50 TR	X 4
3		ROND 653	X 4
4		CAP 653	X 4
5		CALE 482	X 2

F

- Pour accroître la longévité de vos meubles, nous vous recommandons de chauffer et de ventiler votre salle de bains pour éviter l'accumulation de vapeur et d'essuyer les projections d'eau.
- Pour votre complète satisfaction, respecter les consignes d'installation et d'entretien. Leur non respect peut entraîner la perte de la garantie.

GB

- To maximise the service life of furniture units we recommend that your bathroom is properly heated and ventilated. This will prevent the build up of excess moisture and steam stagnation. Wipe with water splashes as they occur with clean cloth.
- For your complete satisfaction carefully read the installation and maintenance instructions provided and retain for reference. Failure to follow the instructions may invalidate the product warranty.

D

- Um eine lange Lebensdauer Ihrer Möbel sicherzustellen, empfehlen wir, das Badezimmer zu heizen und zu lüften, um hohe Luftfeuchtigkeit zu vermeiden. Wasserspritzer sollten trockengewischt werden.
- Damit das Möbelstück Sie vollstens zufriedenstellt, beachten Sie bitte die Installations- und Pflegevorschriften. Bei Nichteinhaltung erlischt der Garantie Anspruch.

DECOTEC
PARIS

1

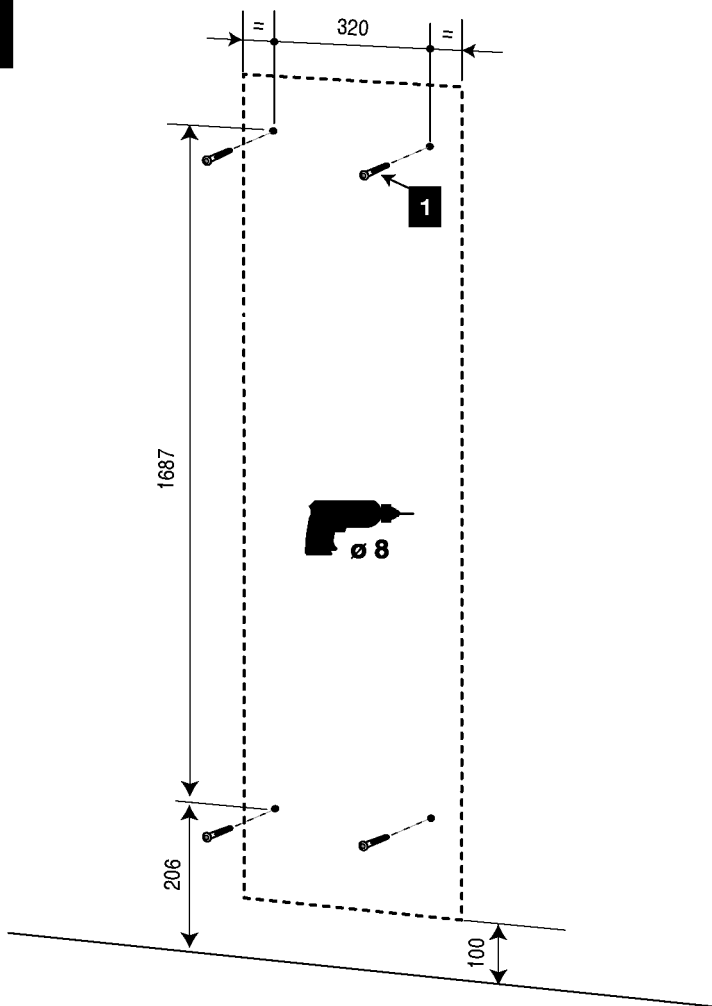

DECOTEC fourni des chevilles polyvalentes à plusieurs supports muraux. Toutefois un support de type BA 13 ou brique creuse nécessite un renforcement de la zone de fixation ainsi que l'utilisation de chevilles adaptées.

DECOTEC liefert Universaldübel für verschiedene Träger. Wir weisen daraufhin, dass ein nicht massiver Träger verstärkt werden muss und trägerspezifische Dübel verwendet werden müssen.

DECOTEC provides universal wall fixing suitable for use in most solid wall installations. Please note that particular attention will be required to use the correct style of wall fixing where hollow/stud wall partitions are involved.

2

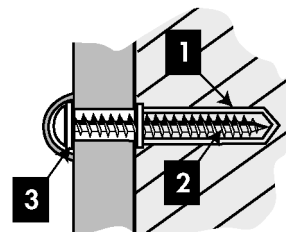
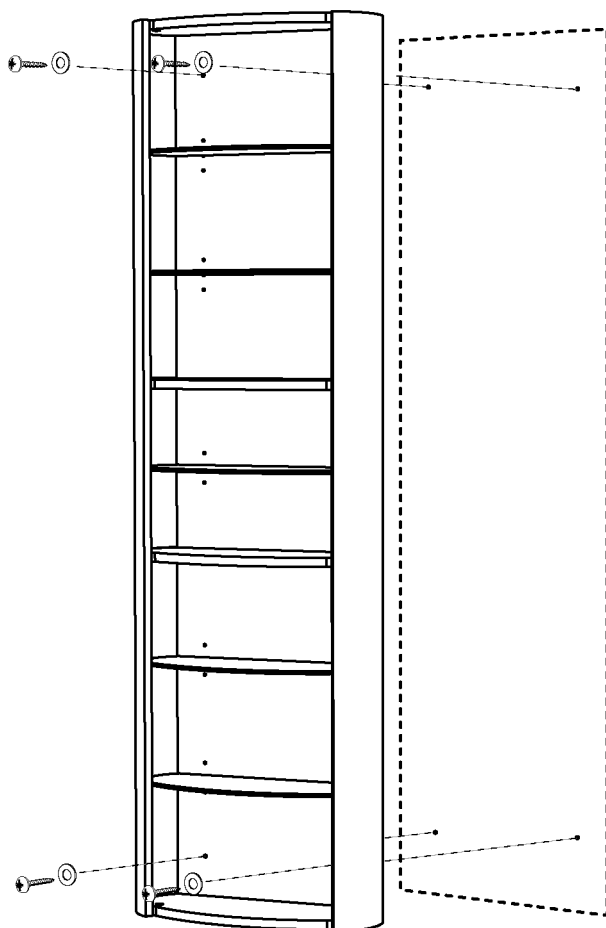

3

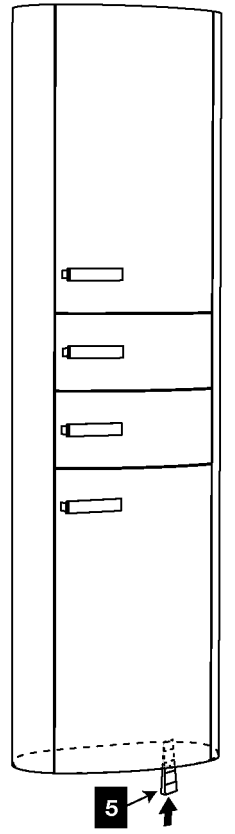
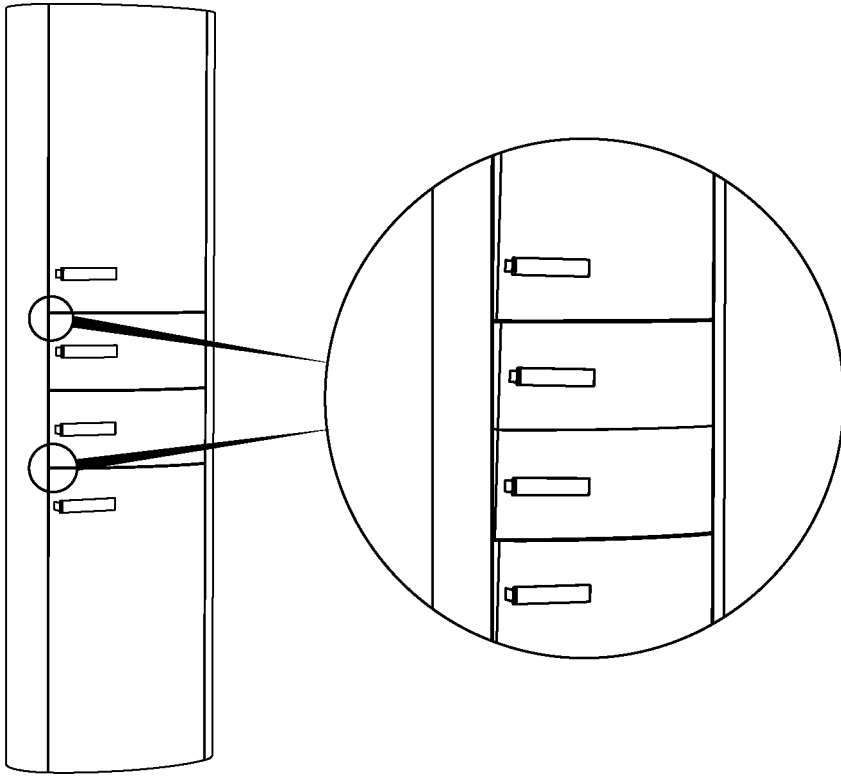

4

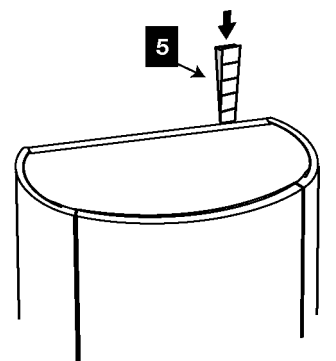
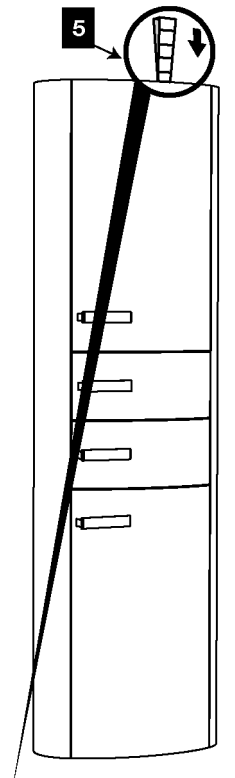
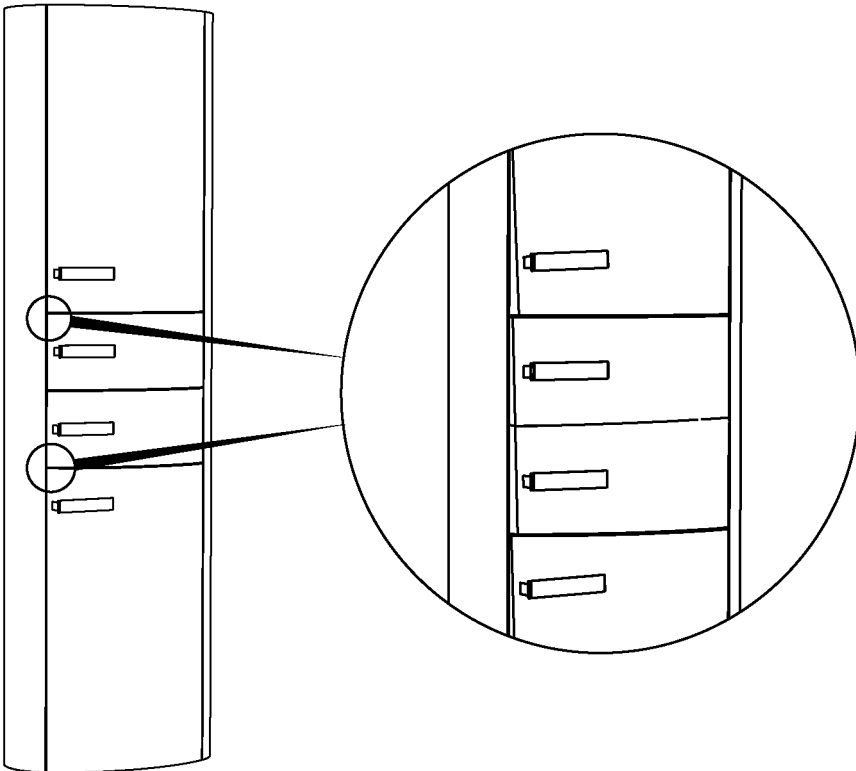

5

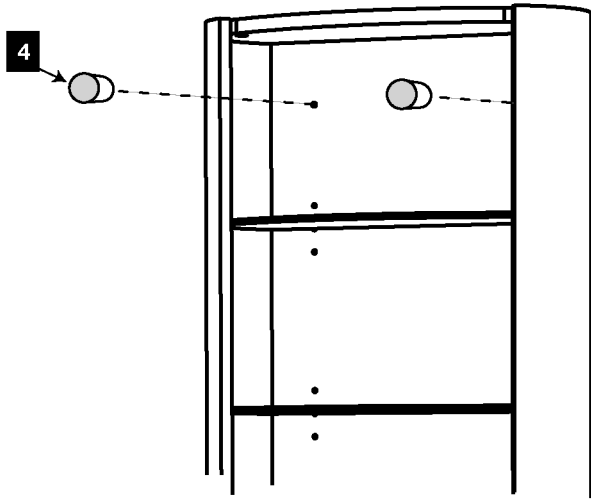

DECOTEC
P A R I S

3, boulevard Voltaire - 75011 Paris Tél. 01 53 36 15 00 - Fax 01 43 38 20 69